

# GIGA.DSS GIGA.DSS+Q

## GradUp



METRIC THREADS

## GIGA DOUBLE SWIVEL SHACKLE

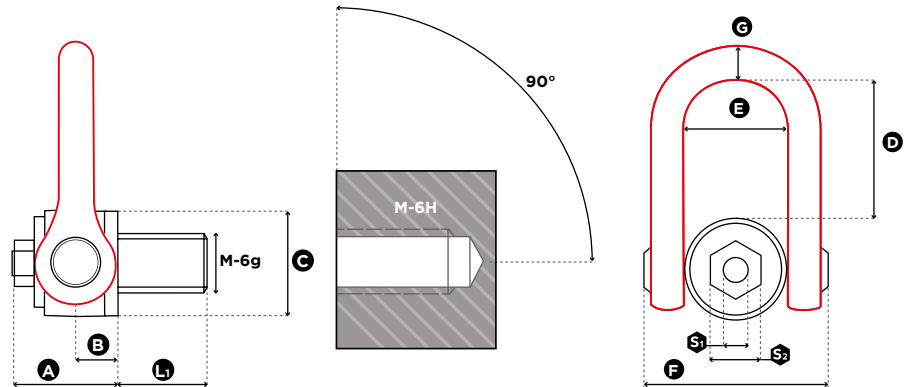

1 in = 25.4 mm

Reference	Diameter	SF 5:1 WLL (t)	Standard L <sub>1</sub> (mm)	Torque (Nm)	S <sub>1</sub> (mm)	S <sub>2</sub> (mm)	A (mm)	B (mm)	C (mm)	D (mm)	E (mm)	F (mm)	G (mm)	Weight (kg)
GIGA.DSS M 150 UP	M 150 (x6)	125,00	228	2000	41	105	271	115	290	353	302	544	103	268

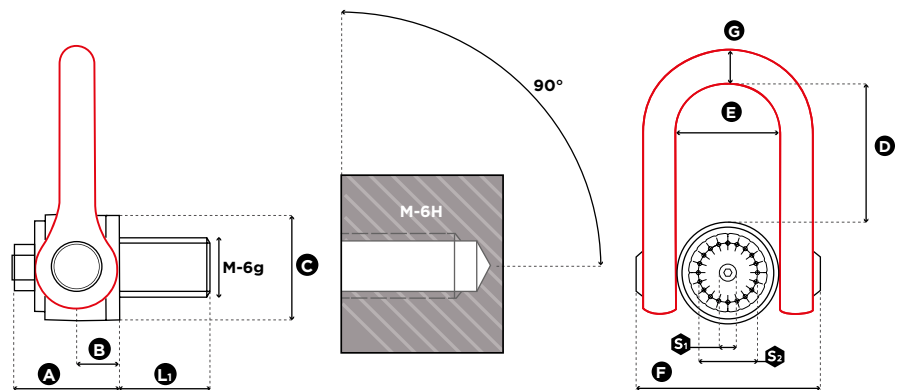

1 in = 25.4 mm

Reference	Diameter	SF 5:1 WLL (t)	Standard L <sub>1</sub> (mm)	Torque (Nm)	S <sub>1</sub> (mm)	S <sub>2</sub> (mm)	A (mm)	B (mm)	C (mm)	D (mm)	E (mm)	F (mm)	G (mm)	Weight (kg)
GIGA.DSS+Q M 150 UP	M 150 (x6)	125,00	230	160	21	XZN N12 DIN 34824	267	115	290	353	302	544	103	268

02.2018